

The Effect of High Transverse Inputs on Accelerometer Calibration

Richard W. Bono, Eric J. Seller
The Modal Shop, Inc.
PCB Group
3149 East Kemper Rd, Cincinnati, OH

ISO 16063 part 21 defines the back-to-back comparison technique for accelerometer calibration. Included in its most recent revision is a recommendation for acceptable limits on shaker transverse motion characteristics. The effect of high transverse inputs can be devastating to accurate accelerometer calibration. This paper discusses the differences between mechanical flexure-based electrodynamic shakers and air bearing shakers and the resulting effects on calibration accuracy and uncertainty.

INTRODUCTION

Discussion about accelerometer calibration often refers primarily to the measurement of voltage sensitivity across a frequency range. The most common way to calibrate accelerometer sensitivity is by comparison to a reference transducer, generally another accelerometer designed to have stable low noise sensitivity in the conditions of calibration. Comparison methods are performed by back-to-back measurements, typically as a stepped sinusoid across an appropriate frequency range. The sensor under test (SUT) is mounted in a back-to-back arrangement against a reference accelerometer and both sensors are subject to a common mechanical excitation. Since the motion input is assumed the same for both devices, the ratio of their outputs is also the ratio of their sensitivities, and the SUT sensitivity can be expressed by the following equation:

$$S_{sut} = S_{ref} \cdot (V_{sut}/V_{ref}) \cdot (G_{ref} / G_{sut})$$

where:

S_{sut} is the SUT sensitivity (in mV/G, mV/(m/s²); pC/G, or pC/(m/s²))

S_{ref} is the reference transducer sensitivity (in mV/G, mV/(m/s²); pC/G, or pC/(m/s²))

V_{sut} is the SUT channel output (in mV)

V_{ref} is the reference channel output (in mV)

G_{sut} is the SUT conditioner gain (in mV/mV or mV/pC)

G_{ref} is the reference conditioner gain (in mV/mV or mV/pC).

ACCELEROMETER VIBRATION SENSITIVITY CALIBRATION

Vibration calibration uses oscillatory (sinusoidal) excitation normally provided by an electrodynamic exciter or shaker with a back-to-back reference accelerometer (see Figure 1). The procedure for measurement of accelerometer sensitivity is described by ISO 16063-21, "Methods for the calibration of vibration and shock transducers - Part 21: Vibration calibration by comparison to a reference transducer" [1]. The shaker is driven by a sinusoidal vibration signal and the sensitivity of the SUT is measured at that particular frequency. Sweeping through the desired range of frequencies then generates a frequency response curve of the SUT, as shown in Figure 2. Typically the amplitude response showing voltage sensitivity is displayed in units of % deviation from a reference sensitivity (commonly either 100 Hz or 159 Hz).

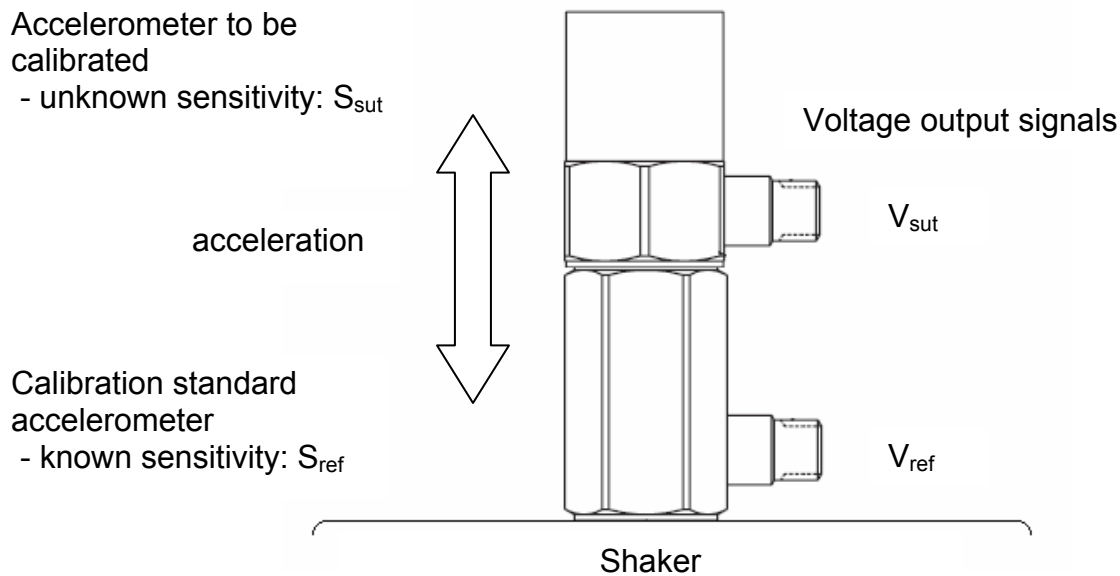

Figure 1: Back-to-back technique

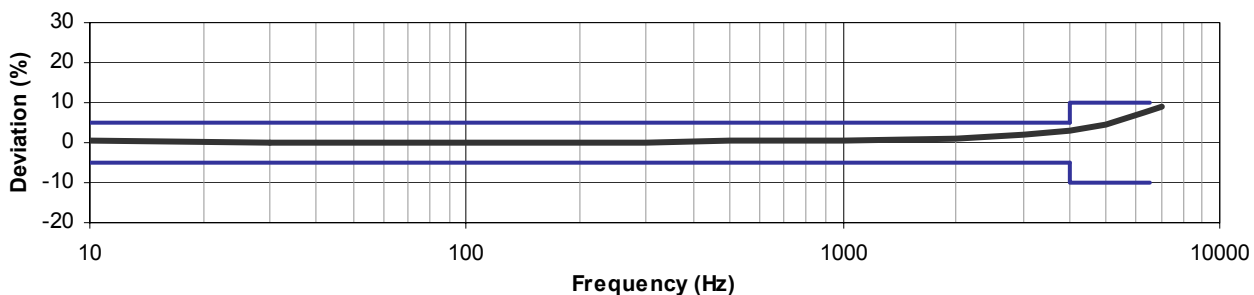

Figure 2: Typical frequency response of an accelerometer. Deviation values refer to calibrated sensitivity at the reference frequency (100 Hz)

Vibration Exciter

Electrodynamic flexure-based exciters (shakers) are commonly used for routine, secondary calibration of accelerometers and often are the “weak link” when calibrating accelerometers. Shakers are structures and have modes of vibration just like any machine. Undesired shaker characteristics, such as excessive transverse motion and waveform distortion will adversely influence the accelerometer’s response, resulting in degraded calibration accuracy.

Transverse motion limits are recommended by ISO 16063-21 to be less than 10% for frequencies below 1000 Hz and less than 30% for frequencies greater than 1000 Hz. Undesired transverse motion from bending and rocking modes of traditional flexure-based shakers can be well over 100% of the primary axis motion, particularly at mid-to-high range frequencies corresponding to a flexure or armature resonance. This cross-axis measurement noise can be easily quantified by using a high frequency triaxial accelerometer mounted at the reference accelerometer mounting surface. Using a PCB Model 356B11 ICP[®] mini-triax and HP 35670A dynamic signal analyzer, swept sine data was acquired to 10 kHz. Applying root-sum-square, the transverse motion vector can be calculated from the accelerometer’s X and Y measurement axes. Comparing this value to the measured motion in the Z axis (normally mounted on the back-to-back reference accelerometer) the transverse motion is calculated as a percentage. Experimental results from testing a typical flexure-based “calibration-grade” shaker and the two

designs of air bearing shakers presented here, compared to the ISO 16063-21 recommended limits, are shown in Figure 3. Data acquired from the flexure-based design exhibits sizeable cross-axis motion measuring 313%, 103% and 165% at 3560 Hz, 8610 Hz and 9122 Hz resonances, respectively. Both precision air-bearing designs show only a very small amount of cross-axis motion, well less than the ISO recommended limits.

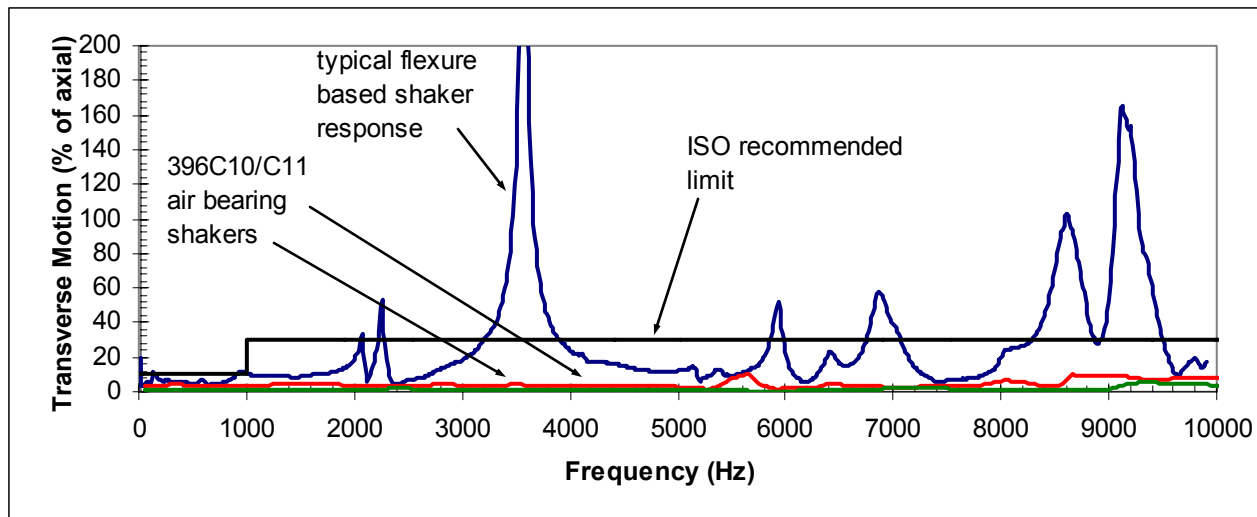

Figure 3. Transverse motion measured on flexure-based and air-bearing calibration shakers, plotted against ISO 16063-21 recommended limits

This large cross-axis excitation motion, coupled with inherent transverse sensitivity found in any accelerometer (test methodologies presented by Sill [2]), results in an increased measurement uncertainty at certain calibration frequencies in the frequency response curve. This error can cause a substantial glitch in the frequency response curve, dependent upon how the maximum axis of transverse sensitivity of the reference accelerometer and accelerometer under test happen to line up against the cross-axis excitation motion. Assuming a perfect reference accelerometer and an accelerometer under test with a transverse sensitivity of 5%, a worst-case calibration error at 3560 Hz due to the influence of the measured 313% transverse motion would be $3.13 \times 0.05 = 15.65\%$. It follows that many calibration technicians often scratch their head trying to understand why apparently intermittent glitches cause such trouble in acquiring acceptable calibration data on certain accelerometers (since this measurement error is only present when axes of accelerometer transverse sensitivity align with the exciter cross-axis motion).

As a result, air bearing shakers are the preferred type of electrodynamic shakers for calibration applications. They provide the best approximation of pure single degree of freedom vibration over the widest frequency range, minimizing measurement uncertainty and errors due to the high transverse motion and distortion of traditional flexure-based electrodynamic shakers. As presented previously by Dosch [3], the air-bearing assembly is composed of an armature fitted within a tight-tolerance porous air-bearing. The gap between the armature and air-bearing is extremely small, maintained at about 2 to 4 microns. Since air film stiffness is inversely proportional to gap, this close fitting gap provides the armature with a high lateral stiffness.

The air bearing shaker tested above is shown in Figures 4 and 5. The armature assembly is composed of two parts: the main body, including separate AC and DC coils, and a removable beryllium insert. The reference accelerometer is located within the insert and back-to-back calibration is performed by mounting the SUT on the insert. The armature insert is electrically isolated from the armature body providing means for the armature body to be isolated from the SUT signal ground. This eliminates any electrical noise contribution from the shaker drive signal on the transducer's measurement, unique to this two-part armature design.

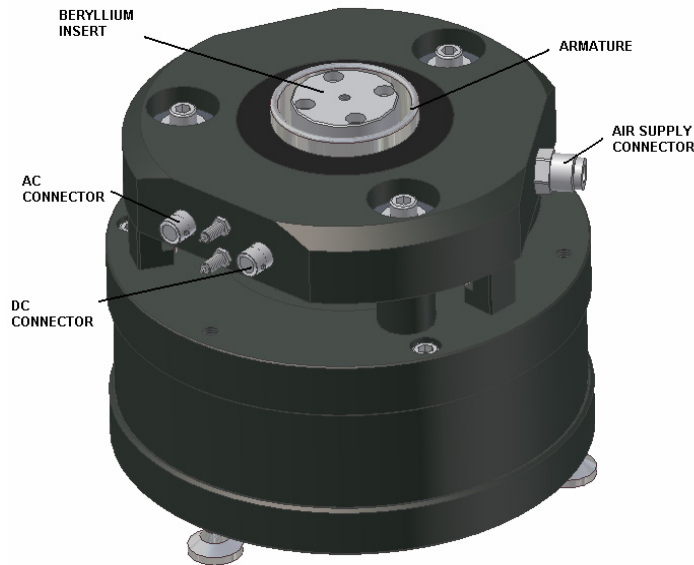

Figure 3: Air bearing shaker [3]

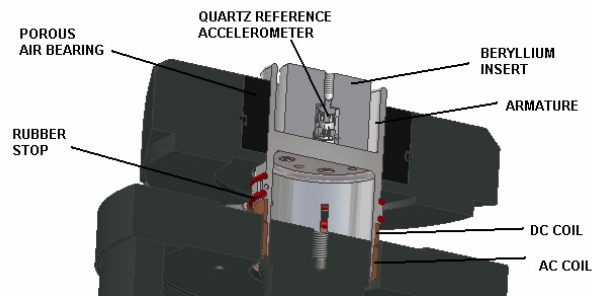

Figure 4: Cross section view of the air bearing shaker [3]

The armature body is fabricated from either aluminum or beryllium. The aluminum design is more common providing excellent calibration signals to 15 kHz while meeting the aforementioned ISO recommended limits. An all-beryllium armature design is also available for extended frequency range calibration. Because beryllium's extremely low density and high stiffness combine to give unusually high speed of sound within the material, structural resonances are therefore very high, so rigid body motion is better approximated, allowing high accuracy calibration up to 20 kHz. The light weight also means higher acceleration levels are possible with the given force. Both the aluminum and beryllium designs also allow for resonance testing up to 50 kHz.

Experimental Calibration Results

A series of calibration data was acquired on a miniature, tear-drop style ICP[®] accelerometer, PCB Model 352B22. The accelerometer was mounted in six angular positions (rotated every 30 degrees from 0° to 180°) on both flexure-based and air-bearing designs. Data was acquired using The Modal Shop's 9155C accelerometer calibration workstation, which utilizes a National Instruments 24 bit DSA card.

Data acquired while using the flexure-based calibration shaker is shown in Figure 6a. The sensor test setup is shown in Figure 6b. By overlaying the calibration frequency response data from the six angular positions, the measurement errors due to the large cross-axis transverse motion around 3500 Hz and 8500 Hz are quite obvious. Notice that the size of the measurement glitch (or error) follows the angular position, with a minimum glitch present at 90° and a maximum glitch located perpendicularly at 0°. Calibration data acquired at 3500 Hz, near the 3560 Hz resonance, both the 0° and 30° position yielded approximately an 8% glitch. Also notice that the glitches are not consistent across each of the three areas of high resonance, since the minimum axis of transverse sensitivity and the actual direction of maximum cross-axis exciter motion will not be the same at different frequencies. In other words, optimizing mounting position to minimize the glitch due to the 3560 Hz resonance doesn't necessarily minimize glitches that result near 8610 Hz and 9122 Hz, or vice versa. As a result, a calibration technician may face serious challenges in producing consistent, acceptable calibration certificates, such as the two shown in Figures 7 and 8 for the same accelerometer under test.

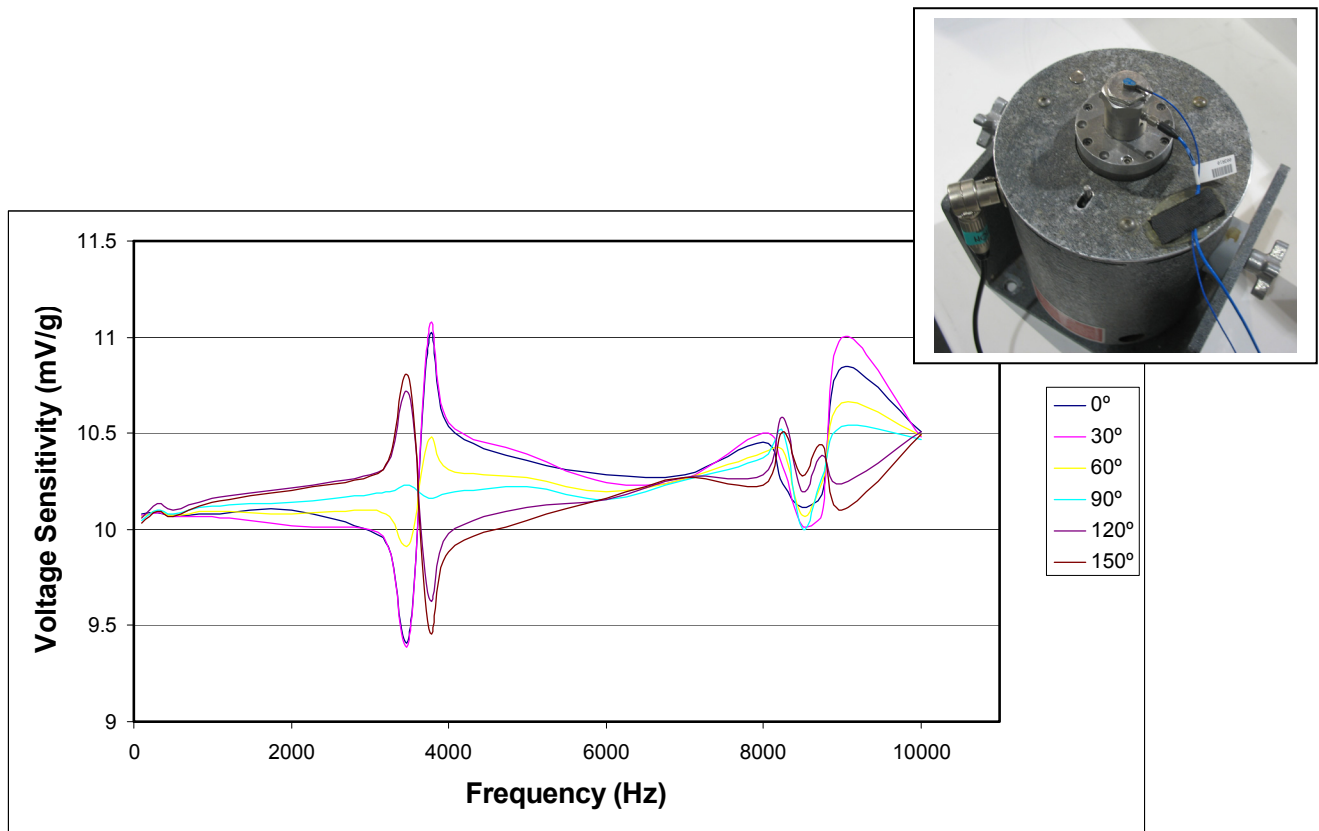

Figure 6. (a) Calibration frequency response data acquired at various rotated positions on flexure-based calibration shaker, (b) Sensor setup mounted on back-to-back reference accelerometer on flexure-based calibration shaker.

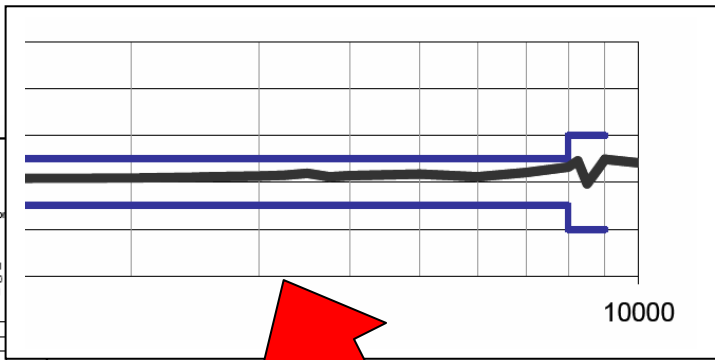
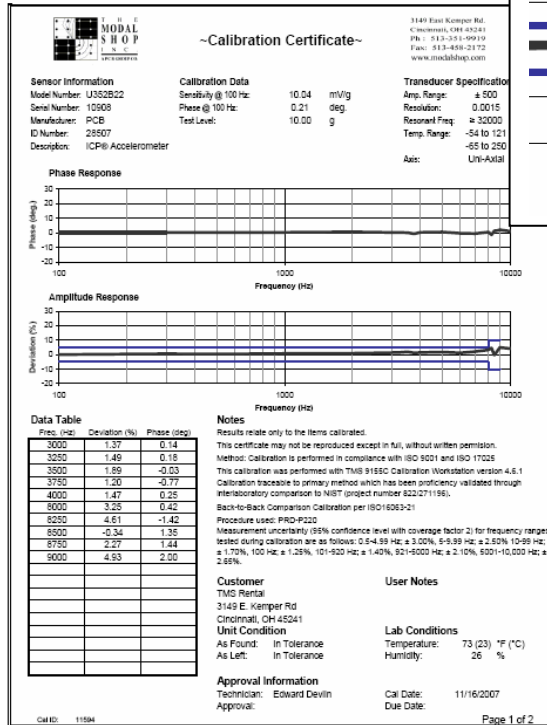

Figure 7. Calibration certificate from the 90° angular position, amplitude response exhibiting small glitch near 3500 Hz exciter resonance

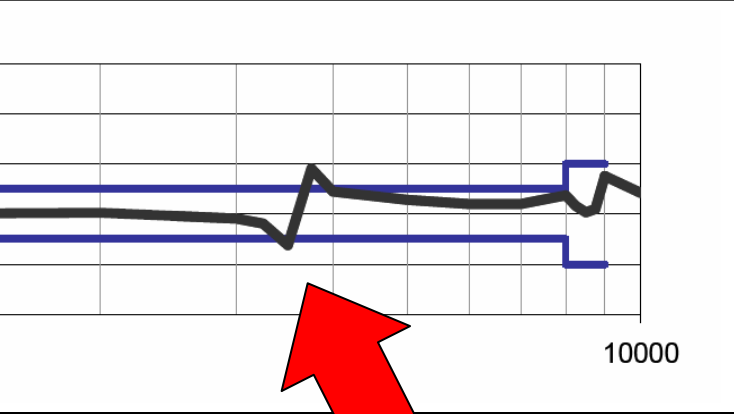
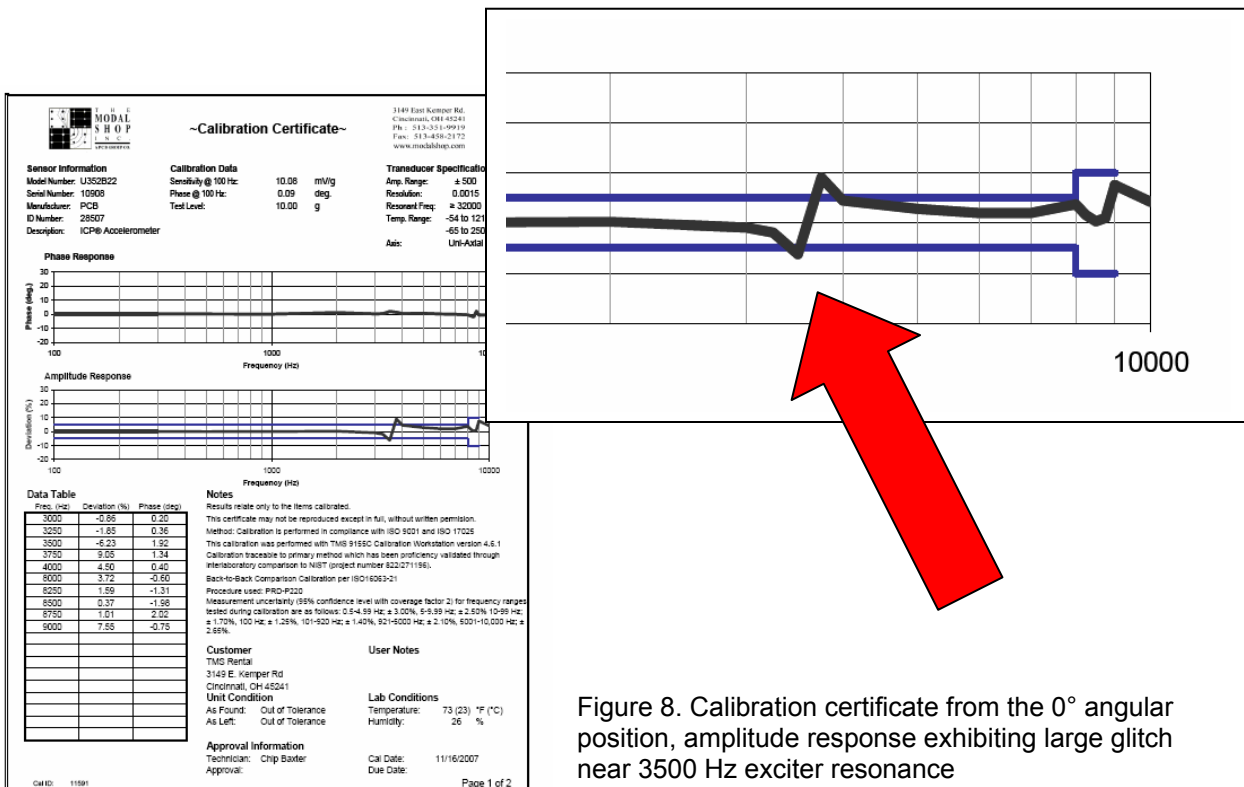

Figure 8. Calibration certificate from the 0° angular position, amplitude response exhibiting large glitch near 3500 Hz exciter resonance

Data acquired while using a precision air-bearing calibration shaker is shown in Figure 9(a). Its sensor test setup is shown in Figure 9(b). Given the minimal amount of cross-axis exciter motion, significantly better results are seen across the entire frequency range, displayed with the same scale as the flexure-based shaker data in Figure 6. An example calibration certificate generated using the precision air-bearing shaker is shown in Figure 10. The calibration data is much more consistent, with significantly reduced uncertainties and much smaller measurement errors.

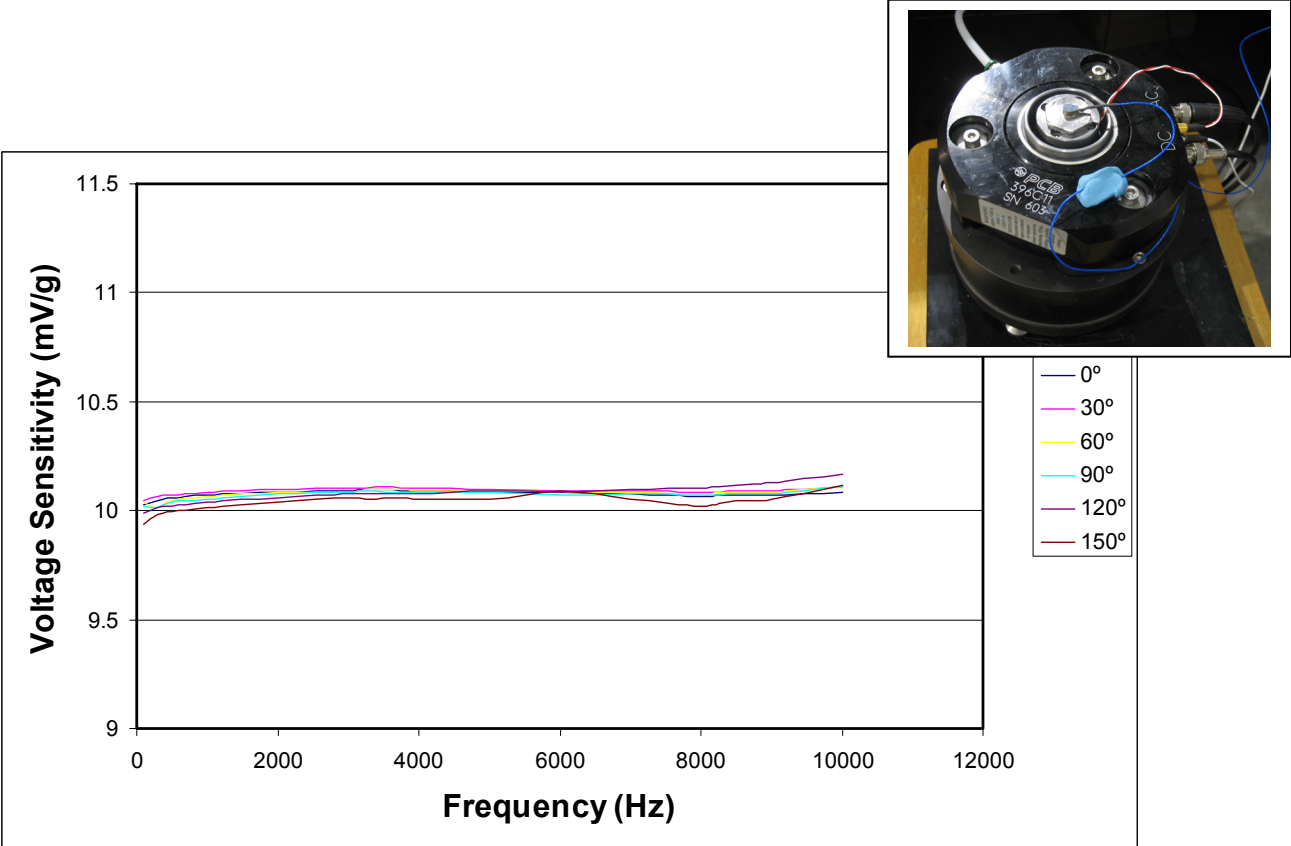

Figure 9. (a) Calibration frequency response data acquired at various rotated positions on precision air-bearing calibration shaker, (b) Sensor setup mounted on insert back-to-back reference accelerometer on air-bearing calibration shaker.

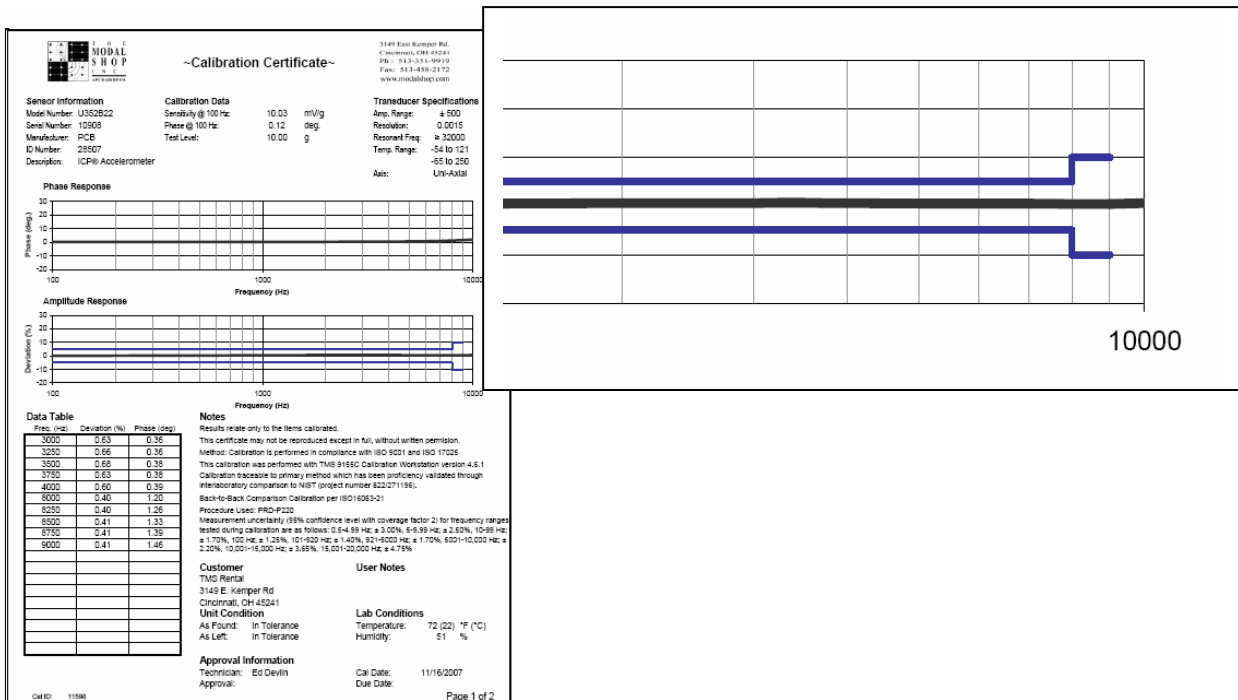

Figure 10. Calibration certificate generated using precision air-bearing calibration shaker. Notice the complete absence of transverse motion induced glitches around 3500 and 9000 Hz.

Effects on Stated System Measurement Uncertainty

ISO 17025 [4] requires that a competent calibration laboratory state measurement uncertainties along with calibration data. In order to adequately define a measurement system’s uncertainty, the appropriate sources of uncertainty must be identified. These may include, but are not limited to, mechanical mounting and orientation, signal conditioning gain and frequency response uncertainty, data acquisition resolution, electronics drift, environmental conditions, etc. Cross-axis exciter motion, as shown previously here, can be a substantial source of measurement uncertainty that is often neglected or handled improperly.

A measurement system’s combined standard uncertainty is found by taking the root-sum-square of the individual component uncertainties. An expanded uncertainty is determined by multiplying the combined standard uncertainty by a coverage factor, k. Generally, a coverage factor of k=2 is used and corresponds to a coverage probability of 95%. Typical published expanded uncertainties using an air bearing shaker consistent with the design presented here is approximately 1.7% to 2.2% over the 1000 Hz to 10,000 Hz range. Given the measurement errors present in the glitches made using a flexure-based shaker, uncertainties are often understated, and really are substantially larger given the presence of significant cross-axis motion. With just 100% transverse motion, the component uncertainty of transverse motion itself can be approximately 1.7%, compared to an estimate of 0.3% with 15% transverse motion.

Conclusion

The electrodynamic shaker is the centerpiece of accelerometer frequency response calibration. Undesired shaker characteristics, particularly transverse motion, waveform distortion, electrical cross-talk, etc. result in poor calibration accuracy. Traditional flexure-based calibration shakers introduce significant measurement errors due to these limitations. It follows that when making high accuracy calibration measurements, a reliable, high fidelity air-bearing shaker is one of the most critical components in the entire test setup. A new design of precision air-bearing shakers has made this realizable.

References

- [1] ISO 16063-21:2003, Methods for the calibration of vibration and shock transducers — Part 21: Vibration calibration by comparison to a reference transducer.
- [2] Sill, Robert D., Seller, Eric J., Accelerometer Transverse Sensitivity Measurement Using Planar Orbital Motion, 77th Shock and Vibration Symposium, November 2006, Monterey, CA, USA.
- [3] Dosch, Jeffrey, Air Bearing Shaker for Precision Calibration of Accelerometers, International Modal Analysis Conference, February 2006, St. Louis MO, USA.
- [4] ISO 17025, General requirements for the competence of testing and calibration laboratories

®ICP is a registered trademark of PCB Group, Inc.